

## **15. Flexible Manufacturing Systems**

- 15.1 Unit Introduction
- 15.2 Unit Objectives
- 15.3 Flexible Manufacturing Systems
- 15.4 FMS Components
- 15.5 FMS Applications and Benefits
- 15.6 FMS Planning and Implementation Issues
- 15.7 Quantitative Analysis of FMS
- 15.8 Unit Review
- 15.10 Self Assessment Questions
- 15.11 Self Assessment Answers

### **15.1 Introduction**

Flexible manufacturing systems (FMSs) are the most automated and technologically sophisticated of the machine cell types used to implement cellular manufacturing. An FMS usually has multiple automated stations and is capable of variable routings among stations, while its flexibility allows it to operate as a mixed model system. The FMS concept integrates many of the advanced technologies that we met in previous units, including flexible automation, CNC machines, distributed computer control, and automated material handling and storage.

#### **KEYPOINT**

A flexible manufacturing system (FMS) is a highly automated group technology machine cell, consisting of a group of processing workstations that are interconnected by an automated material handling and storage system, and controlled by a distributed computer system.

#### **END KEYPOINT**

In this unit we examine the question “what is a FMS?”, which requires an analysis of the meaning of the term flexibility, and the types of FMS that can be met. An investigation of FMS components—workstations, material handling and storage, computer control, and human resources—succeeds this and we examine FMS applications and benefits. FMS planning and implementation issues looks at FMS design recommendations, and operational issues that can occur with the FMS. Some quantitative analysis of the FMS concept in terms of its operating parameters for the bottleneck model, and trying to determine the appropriate size of an FMS.

## 15.2 Learning Objectives

After completing this unit you will be able to:

BULLET LIST

Specify what is meant by a flexible manufacturing system.

Explain the concept of group technology, and how it relates to cellular manufacturing.

Specify the three primary capabilities of flexibility in the FMS.

List the four tests for flexibility in FMS research.

Explain how different types of FMS may be specified.

List the basic components of an FMS.

State the five categories of FMS layout.

Specify the benefits of a successful FMS implementation.

Outline the Major issues of planning for the creation of FMSs.

Specify the types of quantitative analysis that may be used with regard to FMSs.

Explain the concept of the bottleneck model and the extended bottleneck model.

State points that arise from FMS quantitative analysis research.

ENDLIST

## 15.3 Flexible Manufacturing Systems

As defined above, an FMS is a highly automated group technology machine cell, consisting of a group of processing workstations—often computer numerical control machine tools—that are interconnected by an automated material handling and storage system, and controlled by a distributed computer system.

Flexibility is an important part of this definition. As we shall see below, where we discuss it in more detail, flexibility can have different interpretations; but it generally refers to the system's responsiveness to changing demand patterns, so that the mix of part styles in the system, and the production volumes that can be met, can be adjusted rapidly to meet changing requirements.

Another keyword in the definition is group technology, which was discussed in the introduction. In reality no FMS can be perfectly flexible, meaning that there are limits to the range of parts or products that can be made on the system. Consequently an FMS must be designed to produce parts (or products) within a defined range of styles, sizes, and processes—that is, the FMS will have the capability of producing a single part family, or a limited range of part families. It cannot do both.

### **LEARNING ACTIVITY 15.1**

Learn more about the concept of the FMS by visiting the following web-sites:

<http://www.uky.edu/~dsianita/611/fms.html>

[http://en.wikipedia.org/wiki/Flexible\\_manufacturing\\_system](http://en.wikipedia.org/wiki/Flexible_manufacturing_system)

[http://ocw.mit.edu/NR/rdonlyres/Mechanical-Engineering/2-875Fall-2004/ED245A88-3682-42BD-9B98-94B8CB24103E/0/class22\\_fma.pdf](http://ocw.mit.edu/NR/rdonlyres/Mechanical-Engineering/2-875Fall-2004/ED245A88-3682-42BD-9B98-94B8CB24103E/0/class22_fma.pdf)

Write a 1 page report on your findings, and post it to the discussion forum.

### **END LEARNING ACTIVITY 15.1**

As stated above, the FMS concept is based on group technology and cellular manufacturing. Group technology is a manufacturing philosophy in which similar parts are identified and grouped together to take advantage of their similarities in design and production. Similar parts are grouped into so-called “part families” where each part family possesses similar design and/or manufacturing characteristics. Parts are typically grouped into families by one of three means:

#### **NUMLIST**

Visual inspection—where parts with visually-similar features are grouped together

Parts classification and coding—where part similarities, in terms of design attributes and manufacturing attributes, are identified and subsequently coded

Production flow analysis—where parts with similarities are identified by having similar production routings

#### **ENDLIST**

Cellular manufacturing is an application of group technology in which similar machines or processes have been aggregated into cells, each of which is dedicated to the production of a part, product family, or limited group of part families. It is often arranged so that it can cater for all the requirements of the *composite part*—that is, the hypothetical part that includes all possible design and manufacturing attributes of the part family being processed. In lay-out, cellular manufacturing can be arranged as: a single machine cell; a group machine cell with material handling; a group machine cell with semi-integrated handling; or an FMS. The latter formation is the focus of this unit; it is the most highly automated of the group technology machine cells.

The FMS concept first emerged in the 1960s in Britain, before being adopted worldwide. It was generally found that the following conditions favoured its adoption:

#### BULLETLIST

The plant currently uses manned group technology cells, and produces parts in batches, plus there is a desire on management's part to automate

The plant's parts can easily be grouped into part families that can be processed in an FMS; in our case, for the FMS, this means either (1) the parts belong to a common product, or (2) the parts possess similar geometries

The parts or products made by the plant are in the mid-volume (between 5,000-75,000 parts per year), and mid-variety production range, otherwise FMS would prove to be too expensive to implement efficiently

#### ENDLIST

The installing of an FMS is usually a significant capital investment because new equipment is being bought and arranged for the plant, whereas—in the case of a manually operated machine cell—equipment is typically just re-arranged. Further, the FMS is technologically so sophisticated that human personnel must be specially trained to make it operate. However, the benefits of implementing an FMS offset these challenges; these benefits include: increased machine utilization; reduced factory floor space; greater responsiveness to change; lower inventory and manufacturing lead times; and high labour productivity.

### **15.3.1 Flexibility**

The term flexibility has many associations here, in terms of the FMS; these are:

#### BULLETLIST

The capability to identify and distinguish among the different incoming part or product styles processed by the system

The capability of performing a quick changeover of operating instructions

The capability of performing a quick changeover of physical set-up

#### ENDLIST

#### **KEYPOINT**

Flexibility has three primary capabilities in the FMS; it must have the capability: to identify and distinguish among the different incoming part or product styles processed by the system; of performing a quick changeover of operating instructions; and of performing a quick changeover of physical set-up.

## END KEYPOINT

These capabilities are expressed in various ways in the FMS, which can best be seen from an example such as is provided in Figure 15.1. This figure depicts an automated manufacturing cell with two machine tools and robot. The question arising from this figure is: is it a flexible cell? To be considered flexible there are four reasonable tests that can be applied to the system to determine its level of flexibility; these are:

### NUMLIST

1. Part variety test—can the system process different part styles in a non-batch mode?
2. Schedule change test—can the system readily accept changes in the production schedule, either in the product mix or the expected production volume?
3. Error recovery test—can the system recover gracefully from equipment malfunctions and breakdowns, so that production is not completely disrupted?
4. New part test—can new part designs be introduced into the existing product mix with relative ease?

### ENDLIST

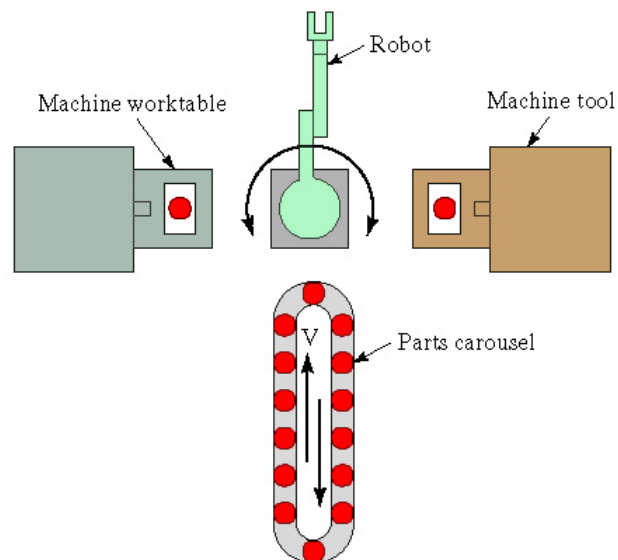

Figure 15.1: Automated manufacturing cell with two machine tools and robot

The system is flexible if we can answer “yes” to all of these questions, with the most important criteria for flexibility being numbers 1 and 2. Numbers 3 and 4 are softer criteria that may be implemented at various levels. In Figure 15.1 the automated manufacturing cell with two machine tools and robot shall be considered flexible if it: (1) can machine different part mixes taken from the

carousel by the robot; (2) allows for changes in the production schedule, without affecting the operation of the robotic arm and the two machine tools; (3) is able to carry-on operating even if one machine tool breaks down; and (4) can accommodate new part designs if the numerical control programme to do so is written off-line and then downloaded by the system for execution.

### **15.3.2 Types of Flexible Manufacturing System**

FMS can be distinguished by how they perform, as either processing operations or assembly operations. FMS are custom-built so that we may expect to find a wide range of types have been implemented to suit differing projects. Each FMS is customized and unique; however, we can still define a typology for FMS depending on: (1) the number of machines it contains; or (2) whether it is a dedicated or random-order FMS, in terms of the parts it processes.

#### **KEYPOINT**

Each FMS is custom-built and unique; however it can be characterised by the number of machines it contains, or by whether it is a dedicated or random-order FMS, in terms of the parts it processes.

#### **END KEYPOINT**

#### **15.3.2.1 Number of Machines**

The following three FMSs can be distinguished in terms of the number of machines it possesses:

##### **NUMLIST**

1. Single machine cell—contains one machine (often a CNC machining centre) connected to a parts storage system, which can load and unload parts to and from the storage system (as in Figure 15. 2). It is designed to operate in batch mode, flexible mode, or a combination of the two. When in batch mode, the system processes parts of a single style in specific lot sizes before physical and programme changeover to the next batch specifications; in flexible mode the system satisfies three of the four tests for flexibility—the exception being error recovery, since, if the CNC machine centre breaks down, the system stops.

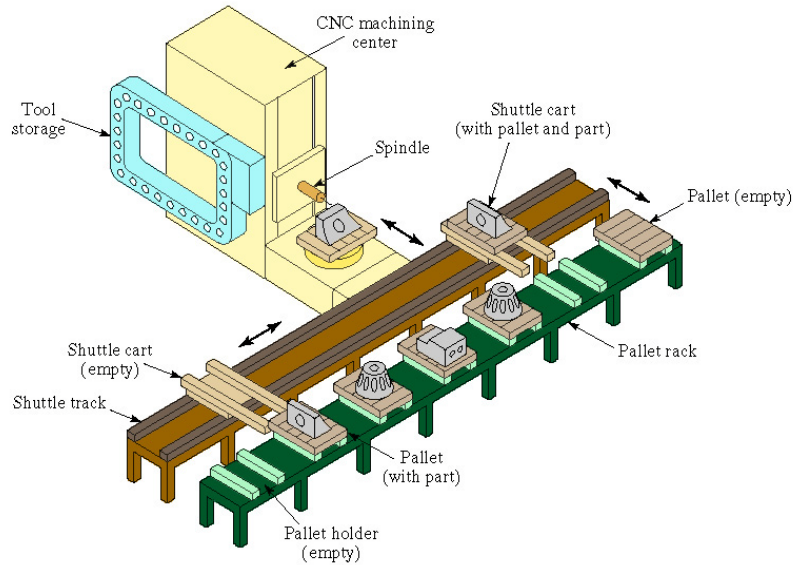

Figure 15.2: Single machine cell with one CNC machining centre and parts storage unit

2. Flexible manufacturing cell—contains two or three processing workstations (often CNC machining or turning centres), plus a parts handling system, as in Figure 15.3. This set-up can operate in flexible mode and batch mode, as necessary, and can readily adapt to evolving production schedule and increased production volumes. Since there is more than one machine, error recovery is possible by re-routing the failed machine's intended parts for processing to the other two machines in the system; and new part designs can be introduced with relative ease into the set-up. The flexible manufacturing cell satisfies all four flexibility tests.

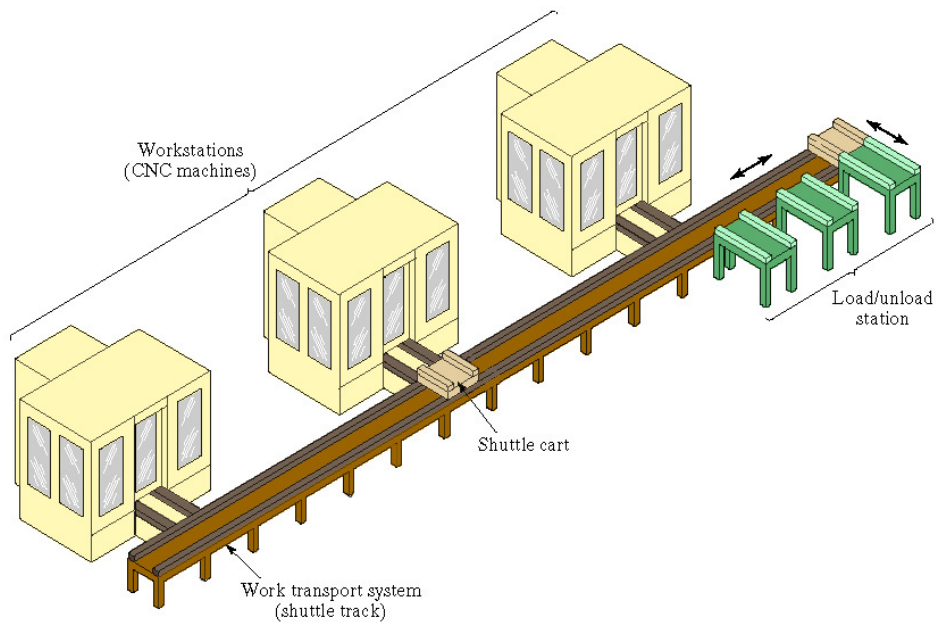

Figure 15.3: Flexible manufacturing cell with three identical processing stations, a load/unload station, and parts handling system

3. Flexible manufacturing system (FMS)—consists of four or more processing stations connected mechanically by a common parts handling system and electronically by a distributed computer system (as in Figure 15.4). FMS is larger than the flexible manufacturing cell, not only in the number of workstations it may contain, but also in the number of supporting stations in the system, such as part/pallet washing stations, co-ordinate measuring machines, storage stations and so on. Computer control is also more sophisticated; it includes functions not found in the flexible manufacturing cell such as diagnostics and tool monitoring. The FMS satisfies all four flexibility tests.

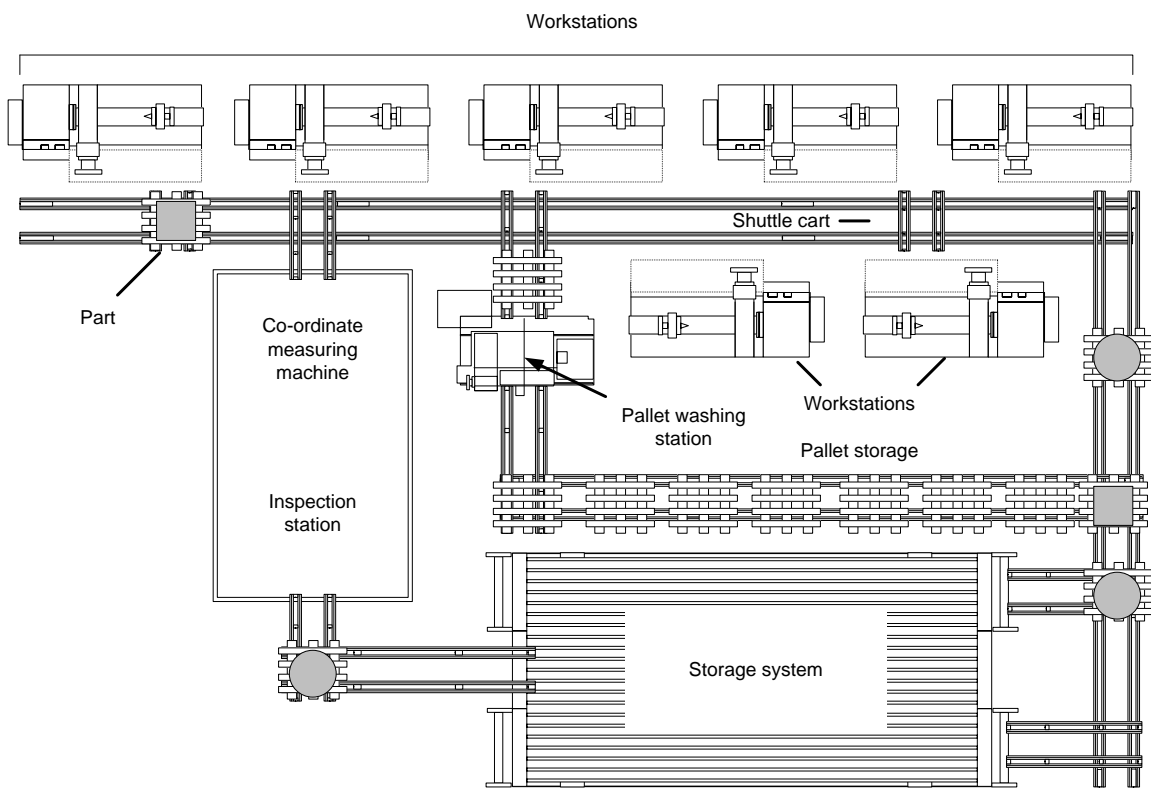

Figure 15.4: Plan view of a seven-station flexible manufacturing system  
ENDLIST

**KEYPOINT**

FMSs can be distinguished in terms of the number of machines it possesses as single machine cells, flexible manufacturing cells, and flexible manufacturing systems.

**END KEYPOINT**

A comparison of the three FMS types is illustrated in Figure 15.5, where the number of machines is plotted against metrics of investment, production rate and annual volume.

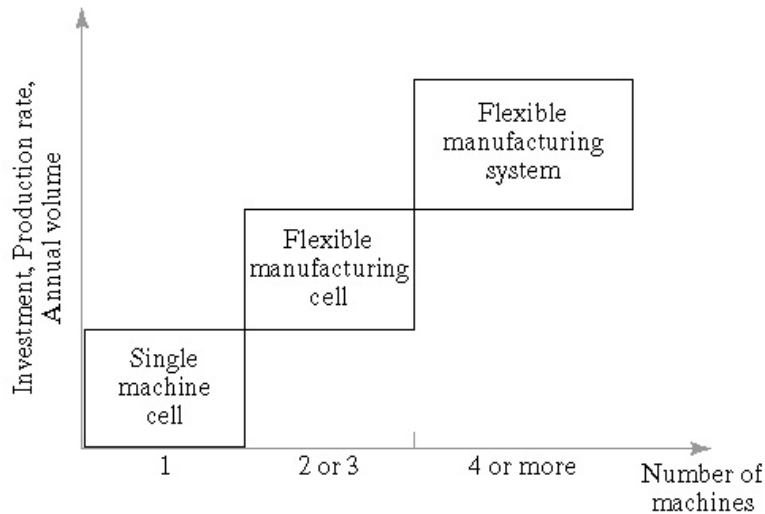

Figure 15.5: Features of the three categories of flexible cells and systems

### 15.3.2.2 Level of flexibility

We can also ascertain the level of flexibility designed into the system.

#### KEYPOINT

The FMS can be examined to determine the level of flexibility it maintains. There are two levels: dedicated FMS, and random-order FMS.

#### END KEYPOINT

The two categories, in more detail, are:

#### BULLETLIST

**Dedicated FMS**—designed to produce a limited variety of part styles, and the complete universe of parts to be made on the system is known in advance. Group technology is likely to be based on product commonality rather than geometric similarity. Product design is relatively stable, so the system is designed with a certain amount of process specialization in place; machines designed for specific processes can be implemented within the system, which leads to an increased production rate from the system. In some cases, machine sequence may be virtually identical for all parts processed, so a transfer line may be appropriate as the system lay-out.

**Random-order FMS**—designed to produce a large part family, where there are substantial variations in part configurations, and where it is likely that new part

designs will be introduced into the system, with engineering changes occurring to existing parts. The production schedule may also be flexible, changing from day to day. The random-order FMS must be more flexible than the dedicated FMS to accommodate these requirements. It is equipped with general purpose machines to deal with product variations, and is capable of processing parts in random order. A more sophisticated computer control system is also required for this FMS type.  
ENDLIST

### KEYPOINT

In dedicated FMS types a limited variety of parts is catered for on a custom-built FMS with specialist machines to achieve high production rates. In the random-order FMS type, a large part family with wide possibilities for future design changes, and changing production schedules, is catered for on a general-purpose FMS with random-order sequencing of parts.

### END KEYPOINT

A comparison of the two FMS types is illustrated in Figure 15.6, where the production rate and annual volume is plotted against metrics of flexibility and part variety.

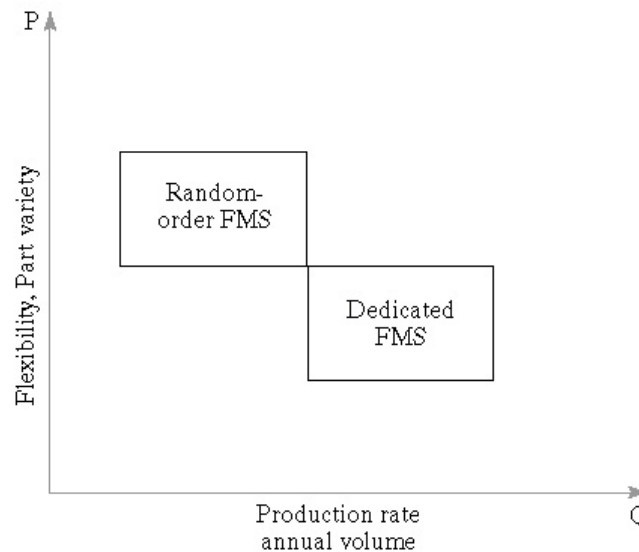

Figure 15.6: Comparison of dedicated and random-order FMS types

## 15.4 Flexible Manufacturing System Components

The basic components of an FMS are: workstations, material handling and storage systems, computer control system, and the personnel that manage and operate the system. These components are discussed in greater detail in the sub-sections below.

## KEYPOINT

Basic components of an FMS are: workstations, material handling and storage systems, computer control system, and the personnel that manage and operate the system.

## END KEYPOINT

### 15.4.1 Workstations

The workstation types to be met with in the typical FMS are detailed in Table 15.1.

Table 15.1: FMS workstation types

Workstation	Description
Load/Unload	<p>Physical interface between the FMS and the rest of the factory, it is where raw parts enter the system, and completely-processed parts exit the system. Loading and unloading can be performed manually by personnel, or it can be automated as part of the material handling system. Should be designed to permit the safe movement of parts, and may be supported by various mechanical devices (e.g. cranes, forklifts).</p> <p>The station includes a data entry unit and monitor for communication between the operator and computer system, regarding parts to enter the system, and parts to exit the system. In some FMSs, various pallet fixtures to accommodate different pallet sizes may have to be put in place at load/unload stations.</p>
Machining	<p>The most common FMS application occurs at machining stations. These are usually CNC machine tools with appropriate automatic tool changing and tool storage features to facilitate quick physical changeover, as necessary.</p> <p>Machining centres can be ordered with automatic pallet changers that can be readily interfaced with the FMS part handling system. Machining centres used for non-rotational parts; for rotational parts turning centres are used. Milling centres may also be used where there are requirements for multi-tooth rotational cutters.</p>
Other	<p>Other possible stations may be found in specific industries, such as—for example—sheet metal fabrication, which has stations for press-working operations, such as punching, shearing, and certain bending and forming processes. Forging is another labour intensive operation which may be broken into specific station categories, such as heating furnace, forging press, and trimming station.</p>
Assembly	<p>Associated with assembly FMSs, the assembly operation usually consists of a number of workstations with industrial robots that sequentially assemble components to the base part to create the overall assembly. They can be programmed to perform tasks with variations in sequence and motion pattern to accommodate the different product styles assembled in the system.</p>
Supporting	<p>Supporting stations may include inspection stations where various inspection tasks may be carried out. Co-ordinate measuring machines, special inspection probes, and machine vision may all be used here.</p> <p>Other supporting stations may include pallet and part washing stations for particularly dirty or oily FMSs, and temporary storage stations for both parts and pallets.</p>

## **KEYPOINT**

The types of workstations that may be utilized in FMSs include: load/unload stations, machining and turning stations, other industry-specific processing stations (such as sheet metal fabrication and forging), assembly stations, and supporting stations.

## **END KEYPOINT**

### **15.4.2 Material Handling and Storage System**

We address material handling and storage systems for FMS in three sub-sections: functions, equipment, and lay-out configurations.

#### **15.4.2.1 Functions of the Handling System**

The following functions of the material handling and storage system in FMSs may be noted:

##### **BULLETLIST**

Allows random, independent movement of workparts between stations so as to allow for various routing alternatives for the different parts in the system

Enables handling of a variety of workpart configurations by means of pallet fixtures for prismatic parts, and industrial robots for rotational parts

Provides temporary storage—small queues of parts awaiting processing may be allowed to build-up in front of each station in the system

Provides convenient access for loading and unloading workparts at load and unload stations

Creates compatibility with computer control—the handling system must be under the direct control of the computer system which directs it to the various workstations, load/unload stations, and storage areas

##### **ENDLIST**

## **KEYPOINT**

Functions of the material handling and storage system in FMSs include: the allowance of random, independent movement of workparts between stations; the handling of a variety of workpart configurations; the provision of temporary storage; the provision of convenient load and unload stations; and the creation of compatibility with computer control.

## **END KEYPOINT**

### 15.4.2.2 Material Handling Equipment

FMS material handling equipment uses a variety of conventional material transport equipment (see unit 8), in-line transfer mechanisms (see unit 13), and industrial robotics (see unit 6). There is a primary and secondary material handling system used in most FMSs. The primary handling system establishes the FMS lay-out and is responsible for moving parts between stations in the system.

The secondary handling system consists of transfer devices, automatic pallet changers, and other mechanisms to transfer parts from the primary material handling system to the workhead of the processing station, or to a supporting station. The secondary handling system is responsible also for the accurate positioning of the part at the workstation, so that the machining process may be performed upon the part in the correct manner. Other purposes of the secondary handling system include: (1) re-orientation of the part if necessary to present the surface that is to be processed; and (2) to act as buffer storage as the workstation, should this be needed.

#### KEYPOINT

FMS material handling equipment consists of a primary handling system to establish material handling lay-out, and a secondary handling system to transfer parts from the primary material handling system to the workhead of the processing station, or to a supporting station.

#### END KEYPOINT

### 15.4.2.3 Flexible Manufacturing System Layout Configurations

There are five categories of FMS layout; these are discussed in detail in Table 15.2.

Table 15.2: Categories of FMS layout

Layout	Description
In-line	The machines and handling system are arranged in a straight line. In Figure 15.7(a) parts progress from one workstation to the next in a well-defined sequence with work always moving in one direction and with no back-flow. Similar operation to a transfer line (see unit 13), except the system holds a greater variety of parts. Routing flexibility can be increased by installing a linear transfer system with bi-directional flow, as shown in Figure 15.7(b). Here a secondary handling system is provided at each workstation to separate most of the parts from the primary line. Material handling equipment used: in-line transfer system; conveyor system; or rail-guided vehicle system.
Loop	Workstations are organized in a loop that is served by a looped parts handling system. In Figure 15.7(c) parts usually flow in one direction around the loop with the capability to stop and be transferred to any station. Each station has secondary handling equipment so that part can be brought-to and transferred-from the station workhead to the material handling loop. Load/unload stations are usually located at one end of the loop.

	An alternative form is the rectangular layout shown in Figure 15.7(d). This arrangement allows for the return of pallets to the starting position in a straight line arrangement.
Ladder	This consists of a loop with rungs upon which workstations are located. The rungs increase the number of possible ways of getting from one machine to the next, and obviates the need for a secondary material handling system. It reduces average travel distance and minimizes congestion in the handling system, thereby reducing transport time between stations. See Figure 15.7(e).
Open field	Consists of multiple loops and ladders, and may include sidings also. This layout is generally used to process a large family of parts, although the number of different machine types may be limited, and parts are usually routed to different workstations—depending on which one becomes available first. See Figure 15.7(f).
Robot-centred	This layout uses one or more robots as the material handling system (see Figure 15.7 (g)).

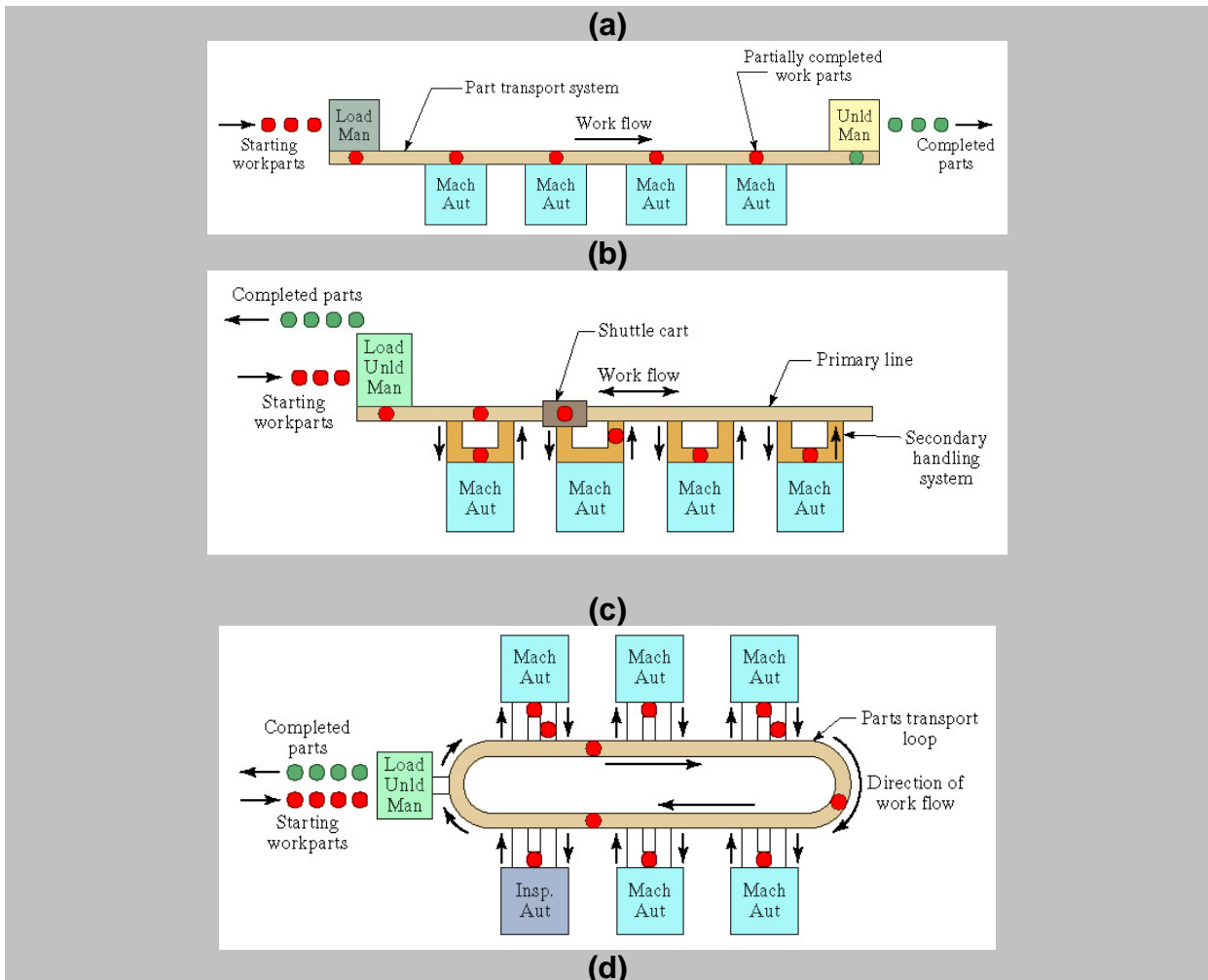

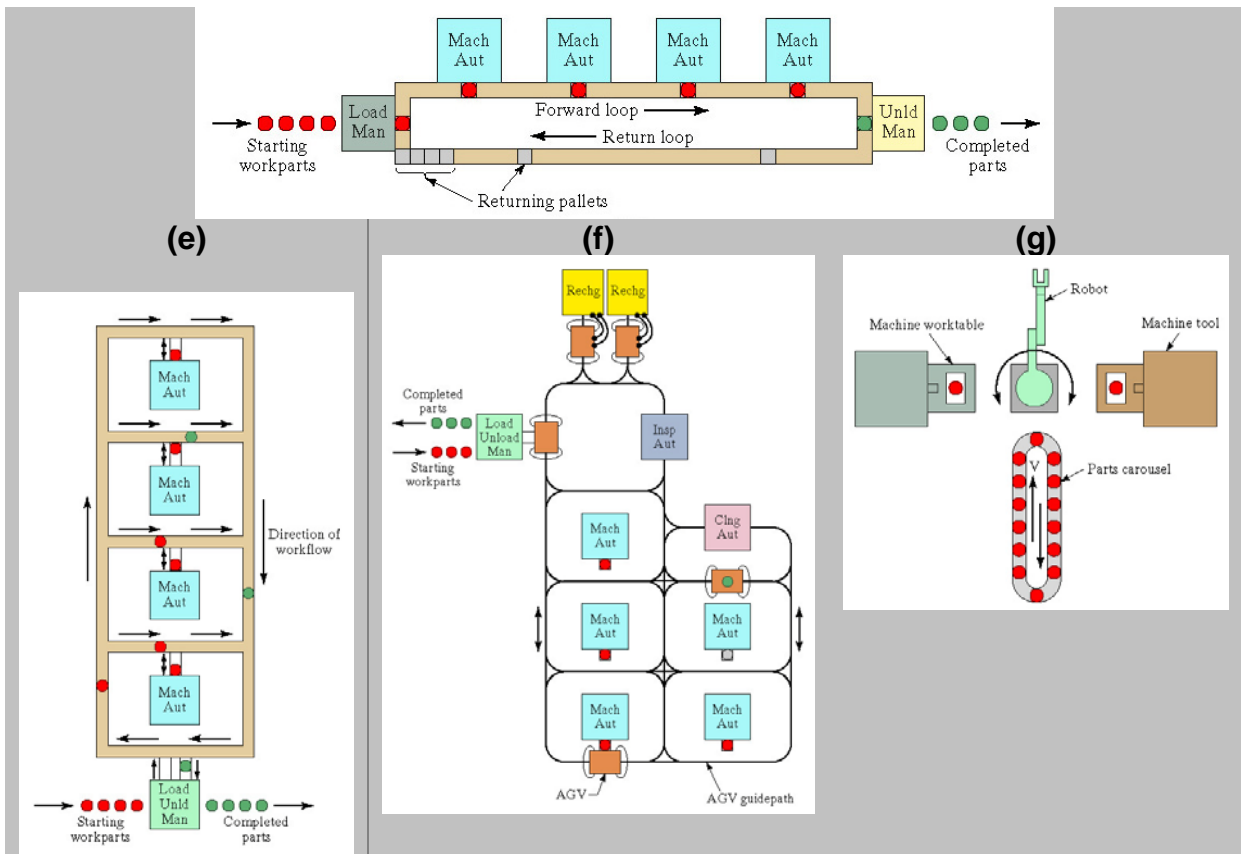

Figure 15.7: FMS layout configurations

**KEYPOINT**

There are five categories of FMS layout; these are: in-line layout; loop layout; ladder layout; open field layout; and robot-centred layout.

**END KEYPOINT**

**15.4.3 Computer Control System**

To operate, the FMS uses a distributed computer system that is interfaced with all workstations in the system, as well as with the material handling system and other hardware components. It consists of a central computer and a series of micro-computers that control individual machines in the FMS. The central computer co-ordinates the activities of the components to achieve smooth operational control of the system. The following control functions may be noted:

**BULLETLIST**

Workstation control—fully automated FMSs use some form of workstation control at each station, often in the form of CNC control

Distribution of control instructions to workstations—a central computer is required to handle the processing occurring at disparate workstations; this involves the

dissemination of part programmes to individual workstations, based upon an overall schedule held by the central computer

Production control—management of the mix and rate at which various parts are launched into the system is important; alongside data input of a number of essential metrics, such as: daily desired production rates, number of raw workparts available, work-in-progress etc.

Traffic control—management of the primary handling system is essential so that parts arrive at the right location at the right time and in the right condition

Shuttle control—management of the secondary handling system is also important, to ensure the correct delivery of the workpart to the station's workhead

Workpiece monitoring—the computer must monitor the status of each cart or pallet in the primary and secondary handling systems, to ensure that we know the location of every element in the system

Tool control—this is concerned with managing tool location (keeping track of the different tools used at different workstations, which can be a determinant on where a part can be processed), and tool life (keeping track on how much usage the tool has gone through, so as to determine when it should be replaced)

Performance monitoring and reporting—the computer must collect data on the various operations on-going in the FMS and present performance findings based on this

Diagnostics—the computer must be able to diagnose, to a high degree of accuracy, where a problem may be occurring in the FMS  
ENDLIST

#### **KEYPOINT**

The computer control system in an FMS has the following functions: workstation control; distribution of control instructions to workstations; production control; traffic control; shuttle control; workpiece monitoring; tool control; performance monitoring and reporting; and diagnostics.

#### **END KEYPOINT**

### **15.4.4 Human Resources**

Human personnel manage the overall operations of the system. Humans are also required in the FMS to perform a variety of supporting operations in the system; these include: loading raw workparts into the system; unloading finished parts or assemblies from the system; changing and setting tools; performing equipment

maintenance and repair; performing NC part programming; programming and operating the computer system; and managing the system.

**KEYPOINT**

Although not intrinsically considered as part of the FMS, humans nevertheless manage the overall operations of the system, and perform a number of supporting tasks in the system.

**END KEYPOINT**

## **15.5 Flexible Manufacturing System Applications and Benefits**

In the following paragraphs we examine some applications and benefits of FMSs. In general it has been found that manufacturing operations can readily exploit concepts of flexible automation, for such tasks as machining, for example—but also for other tasks that may be met in the production environment, such as assembly, forging, and sheet metal pressworking.

In machining there has been a historical preference for milling and drilling type operations in FMSs. These operations process non-rotational parts using CNC machining centres. Until recently, FMSs that could handle rotational parts, and put in place turning centre workstations that could process these, were much less common. The systems installed for rotational part processing tend to have fewer machines than its non-rotational counterpart. The reasons for the difference in the pace of development of rotational and non-rotational FMSs include:

**BULLETLIST**

Non-rotational parts are usually too heavy for a human operator to load easily into the machine tool; this gave rise to creation of specialized pallet fixtures and material handling systems to perform this task without human intervention—all of which became chief components in the creation of FMSs.

Non-rotational parts tend to be more expensive than rotational parts, which required them to be made as efficiently as possible; hence the use of FMS for these parts, before much consideration was given for an equivalent FMS for rotational parts.

**ENDLIST**

**KEYPOINT**

Historically, FMSs that could process non-rotational parts have been more predominant than FMSs that could process rotational parts. The reasons for this include the early development of system components to handle non-rotational parts, and the need to machine non-rotational parts in a less expensive, more efficient, manner.

**END KEYPOINT**

An example of a non-rotational FMS is illustrated in Figure 15.8, which is taken from the Vought Aerospace plant in Dallas, US. This system is used to machine approximately 600 different aircraft components, by means of an FMS with eight CNC horizontal machining centres, plus inspection modules. Automated guided vehicles are used as the primary and secondary material handling system. There are two load and unload stations in the system, both of which maintain carousels so that parts may be stored on pallets before and after production. This system can process a sequence of single, one-of-a-kind parts in a continuous mode, so a complete set of components for one aircraft may be made efficiently without batching.

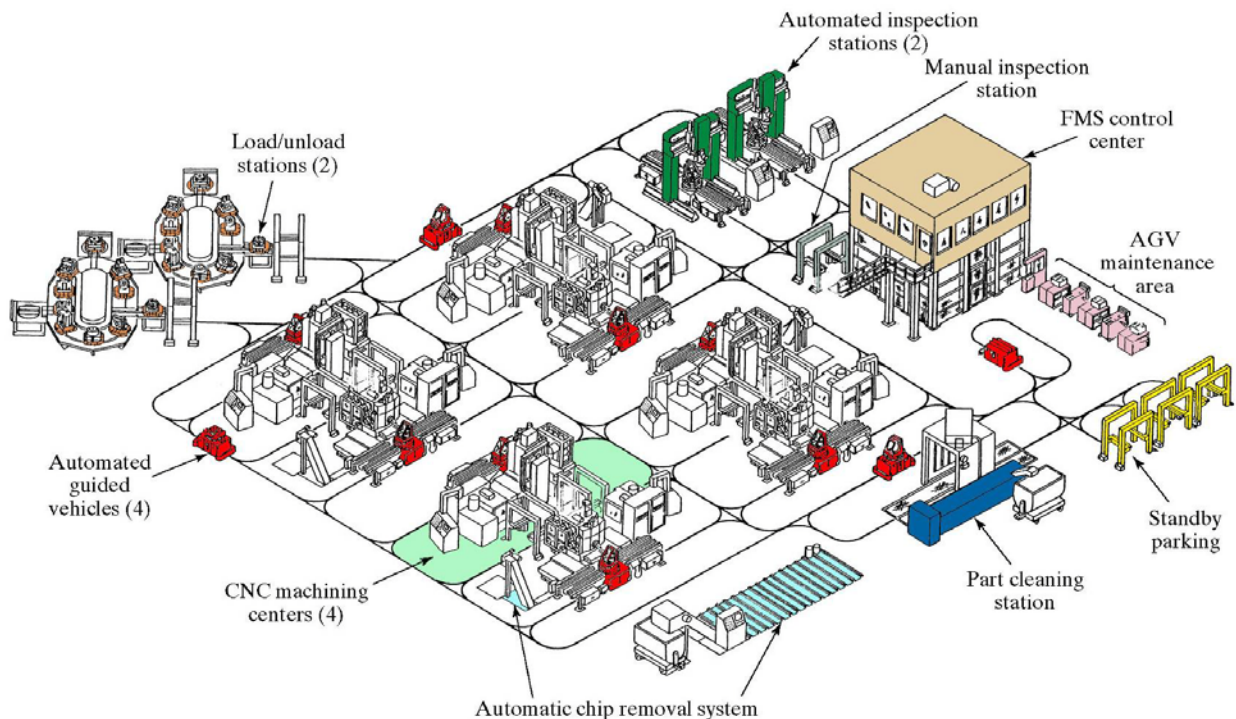

Figure 15.8: FMS at Vought Aircraft

An example of a fabricating FMS for automated sheet-metal processing is shown in Figure 15.9, based upon the FMS at the Allen-Bradley Company. This FMS produces motor starters in 125 model styles; with the line having a one-day manufacturing lead time on lot sizes as low as one, and production rates of 600 units per hour. There are 26 workstations in the system: these perform all the processes necessary to complete the product, from assembly, sub-assembly, testing, and packaging. Workstation composition includes the use of linear and dial-indexing assembly machines, with pick-and-place robots performing the handing functions between workstations. Each step uses 100% automated testing to ensure very high quality levels.

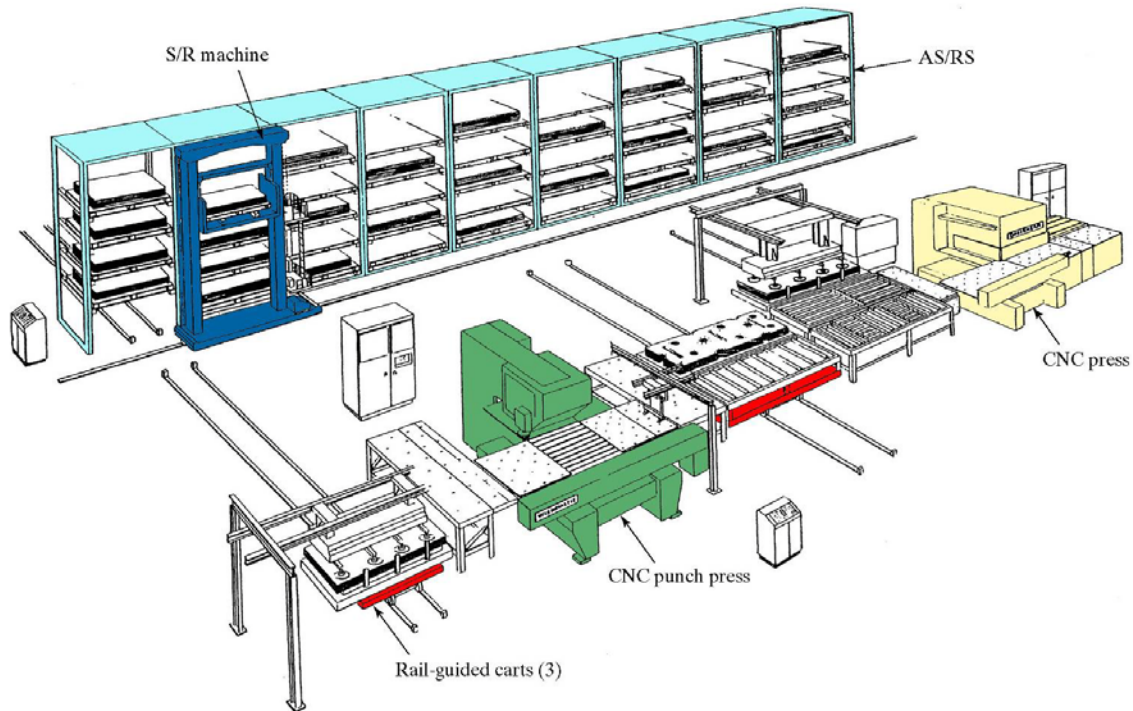

Figure 15.9: Flexible fabricating system for automated sheet-metal processing

The following benefits accrue from using FMS applications that are successful:

**BULLETLIST**

Increased machine utilization—owing to 24 hr per day operation, automatic tool changing of machine tools, automatic pallet changing at workstations, queues of parts at stations, and dynamic scheduling of production that compensates for irregularities

Fewer machines required—because existing machines are highly flexible, and because of higher machine utilization

Reduction in the amount of factory floor space required

Greater responsiveness to change—owing to the inherent flexibility of the system

Reduced inventory requirements—work-in-process is reduced because different parts are processed together, and not in batches

Lower manufacturing lead times

Reduced direct labour requirements and higher labour productivity—higher production rates and lower reliance on direct labour mean greater productivity per labour hour with an FMS than with conventional production methods

Opportunity for unattended production—the system can operate for long periods without human attention  
ENDLIST

**KEYPOINT**

Benefits of successful FMS applications include: increased machine utilization; fewer machines required; reduction in the amount of factory floor space required; greater responsiveness to change; reduced inventory requirements; lower manufacturing lead times; reduced direct labour requirements and higher labour productivity; and opportunities for unattended production.

**END KEYPOINT**

**15.6 Flexible Manufacturing System Planning and Implementation Issues**

We consider FMS planning and implementation under two heading here: planning and design issues, and operational issues.

**15.6.1 FMS Planning and Design Issues**

Table 15.3 outlines the major issues of planning that have to be undergone first to create an FMS.

Table 15.3: Planning issues for FMSs

Issue	Description
Part family considerations	A choice has to be made regarding group technology, and the part family to be produced on the FMS. The FMS cannot be completely flexible, and so cannot handle any part whatsoever; there must be some consideration on the creation of a composite part, with all possible physical attributes of the parts that may be processed in the FMS.
Processing requirements	Once the entire range of possible parts to be processed are known, we must use this information to help choose associated processing requirements for each part, and thus the type of equipment that should be used to process the parts.
Physical characteristics of the workparts	Size and weight of workparts determine size of the machines required to process the parts. It also determines the size of the material handling system needed.
Production volume	Production quantities must be determined, as these tell us how many machines of each type will be required.

**KEYPOINT**

Major issues of planning for the creation of FMSs include: part family considerations; processing requirements; physical characteristics of the workparts; and production volume.

**END KEYPOINT**

Once planning issues have been finalized, a number of design issues may be tackled. These are outlined in Table 15.4.

Table 15.4: Design issues for FMSs

Issue	Description
Types of workstations	Workstation choices have to be made, depending on part processing requirements. We must consider position and use of load and unload stations also.
Variations in process routings and FMS layout	If part processing variations are minimal, we may decide to use an in-line flow; if part processing variations are high, we may instead opt for a loop flow, or higher still, for an open field layout.
Material handling system	We must select an appropriate primary and secondary material handling system to suit the layout chosen.
Work-in-process and storage capacity	Determining an appropriate level of WIP allowed is important, as it affects the level of utilization and efficiency of the FMS. Storage capacity must be compatible with the level of WIP chosen.
Tooling	We must determine the number and type of tools required at each workstation. How much duplication of tooling should occur at workstations? Duplication allows for efficient re-routing in the system should breakdowns occur.
Pallet fixtures	For non-rotational parts, selection of a few types of pallet fixtures is important. Factors that influence the decision include: levels of WIP chosen, and differences in part style and size.

### KEYPOINT

Major issues of design for the creation of FMSs include: workstation type; consideration of the variations in process routings and FMS layout; choice of material handling system; work-in-process and storage capacity decisions; tooling choices; and pallet fixture considerations.

### END KEYPOINT

## 15.6.2 FMS Operational Issues

Following FMS installation, there are a number of operational problems that must be monitored on a regular basis. These are detailed in Table 15.5.

Table 15.5: Operational issues for FMSs

Issue	Description
Scheduling and dispatching	Scheduling must be considered for the FMS, based upon the Master Production Schedule. Dispatching is concerning with launching the parts into the system at the appropriate times.
Machine loading	We must choose how to allocate specific parts to specific machines in the system, based upon their tooling resources and routing considerations of the FMS.
Part routing	Routing decisions involve the choice of a route that should be followed by a part in the system. Consideration should be given to other parts travelling in the system, traffic management etc.
Part grouping	Part types must be grouped for simultaneous production, given limitations on available tooling and other resources at workstations.

Tool management	We must determine when best to change tools, how long each tool can last before requiring maintenance, and how to allocate tooling to workstations in the system.
Pallet and fixture allocation	How do we allocate specific pallets and fixtures to certain parts to be launched into the system? Different parts require different pallet fixtures, and before a given part style can be launched into the system, a fixture for that part must be made available.

**KEYPOINT**

FMS operational problems include issues of: scheduling and dispatching; machine loading; part routing; part grouping; tool management; and pallet and fixture allocation.

**END KEYPOINT**

**15.7 Quantitative Analysis of Flexible Manufacturing Systems**

FMSs can be analysed under four different approaches; these are:

**NUMLIST**

Deterministic models—that is, models that are used to gain starting estimations of system performance, but not for complex phenomena, such as the build-up of queues and other dynamics that can impair system performance.

Queuing models—these attend to issues of queuing not examined in deterministic models, and they examine various simple system configurations.

Discrete event simulation—often used in the latter parts of system design to determine the most accurate methods for modelling specific attributes of the FMS. Characteristics handled here include layout configuration, number of pallets in the system, and production scheduling rules.

Other techniques—this is a hold-all title that includes various approaches, from mathematical programming, heuristic approaches, and a number of operational research techniques.

**ENDLIST**

**KEYPOINT**

FMSs are generally analysed under deterministic and queuing methodologies in the early stage of system; while, in later stages, discrete event simulation is used to handling general system characteristics.

**END KEYPOINT**

We focus upon the most important approach in the sub-sections below, the deterministic modelling approach.

### 15.7.1 Bottleneck model

Here we focus upon the deterministic model known as the bottleneck model. The bottleneck model is simple and intuitive in approach, and can be used to determine a number of FMS starting parameters (later to be adjusted when the FMS is running). The term bottleneck refers to the fact that the output of the production system has an upper limit, given that the product mix flowing through the FMS is fixed.

#### KEYPOINT

For deterministic modelling, we examine the bottleneck model, which is a model that examines the production system's upper limit, given that the product mix flowing through the FMS is fixed.

#### END KEYPOINT

In the bottleneck model the following terminology and symbols are relevant. Part mix, or the mix of the various parts or product styles produced by the FMS, is defined as:

$$\sum_{j=1}^P p_j = 1.0$$

where  $p_j$  is the fraction of the total system output that is of style  $j$ ; and where  $P$  is the total number of different part styles made in the FMS. The number of workstations in the system is defined by  $n$ , and in the bottleneck model each workstation may have more than one server (two or more machines capable of performing the same operation). Let  $s_i$  be the number of servers at workstation  $i$ , where  $i = 1, 2, \dots, n$ .

In bottleneck modelling, process routing defines the sequence of operations, the workstations where operations are performed, and associated process times. We can let  $t_{ijk}$  be the processing time (the total time that a production unit occupies a given workstation server, not counting waiting time); where  $i$  is the station,  $j$  is the part/product style, and  $k$  refers to the sequence of operations in the process routing.

For work handling, the material handling system is considered as a special-case workstation in the bottleneck model. It is designated as  $n + 1$ , with the number of carriers in the system being equated to the number of servers in a workstation. Thus  $s_{n+1}$  can become the number of carriers in the FMS handling system. For transport, we can let  $t_{n+1}$  be the mean transport time required to move a part from one workstation to the next station in process routing; where  $t$  is transport time.

Finally, operation frequency is defined as the expected number of times a given operation in the process routing is performed for each work unit. We can let  $f_{ijk}$  be

the operation frequency for operation  $k$  in process plan  $j$ , at station  $i$ , and where  $f$  is represents operation frequency.

Using these terms we can represent FMS operational parameters in the context of the bottleneck model. Average workload is calculated as:

$$WL_i = \sum_j \sum_k t_{ijk} f_{ijk} p_j$$

The work handling system is a special case and is treated as an extra station. The average number of transports is:

$$n_t = \sum_i \sum_j \sum_k f_{ijk} p_j - 1$$

Thus, the workload of the handling system is:

$$WL_{n+1} = n_t t_{n+1}$$

### KEYPOINT

The bottleneck model allows us to determine initial values for the average workload of individual stations in the FMS, the average number of transports in the system, and the average workload of the material handling system.

### END KEYPOINT

Other important performance measures used in the bottleneck model can also be calculated. The workload per server is given as:

$$WL_s = \frac{WL_i}{s_i}$$

If we let  $WL^*$  and  $s^*$  be the workload and number of servers, respectively, for the bottleneck station, then the maximum production rate ( $R_p^*$ ) of all parts of the FMS can be determined as the ratio of these two entities; that is:

$$R_p^* = \frac{s^*}{WL^*}$$

The value of  $R_p^*$  includes parts of all styles produced in the system. Individual part production rates are obtained by  $R_p^*$  by the respective part mix ratios; that is:

$$R_{pj}^* = p_j R_p^*$$

Utilization at each workstation is:

$$U_i = \frac{WL_i}{s_i} R_p *$$

Based on this, average station utilization is:

$$\bar{U} = \frac{\sum_{i=1}^{n+1} U_i}{n+1}$$

Overall FMS utilization is calculated as:

$$\bar{U}_s = \frac{\sum_{i=1}^n s_i U_i}{\sum_{i=1}^n s_i}$$

Finally, the number of busy servers at each station is given as:

$$BS_i = WL_i R_p *$$

where  $BS_i$  is the number of busy servers on average at station  $i$ .

### **KEYPOINT**

Additional performance measures that can be computed for the bottleneck model include: the workload per server; the maximum production rate; individual part production rates; and the utilization of individual workstations, and the overall FMS utilization.

### **END KEYPOINT**

### **EXAMPLE 15.1**

A flexible manufacturing cell has just been created. After considering a number of designs, the system engineer chose a layout that consists of two machining workstations plus a load/unload station. In detail, the layout consists of:

#### **BULLETLIST**

The load/unload station is station 1.

Station 2 performs milling operations and consists of one server (one CNC milling machine).

Station 3 has one server that performs drilling (one CNC drill press).

The three stations are connected by a part handling system that has one work carrier.

ENDLIST

The mean transport time in the system is 2.5 min. The FMC produces three parts, A, B, and C. The part mix fractions and process routings for the three parts are presented in the table below. The operation frequency  $f_{ijk} = 1.0$  for all operations.

Determine (a) maximum production rate of the FMC, (b) corresponding production rates of each product, (c) utilization of each machine in the system, and (d) number of busy servers at each station.

Part $j$	Part mix $p_j$	Operation $k$	Description $n$	Station $i$	Process time $t_{ijk}$
A	0.2	1	Load	1	3 min
		2	Mill	2	20 min
		3	Drill	3	12 min
		4	Unload	1	2 min
B	0.3	1	Load	1	3 min
		2	Mill	2	15 min
		3	Drill	3	30 min
		4	Unload	1	2 min
C	0.5	1	Load	1	3 min
		2	Drill	3	14 min
		3	Mill	2	22 min
		4	Unload	1	2 min

**Solution:**

(a) Use formula to calculate average workload at each station:

$$WL_i = \sum_j \sum_k t_{ijk} f_{ijk} p_j$$

$$WL_1 = (3+2)(0.2)(1.0) + (3+2)(0.3)(1.0) + (3+2)(0.5)(1.0) = 5.0 \text{ min}$$

$$WL_2 = 20(0.2)(1.0) + 15(0.3)(1.0) + 22(0.5)(1.0) = 19.5 \text{ min}$$

$$WL_3 = 12(0.2)(1.0) + 30(0.3)(1.0) + 14(0.5)(1.0) = 18.4 \text{ min}$$

$$n_t = 3(0.2)(1.0) + 3(0.3)(1.0) + 3(0.5)(1.0) = 3, \quad WL_4 = 3(2.5) = 7.5 \text{ min}$$

Bottleneck station is determined by formula:

$$WL_s = \frac{WL_i}{s_i}$$

The station with the largest  $WL_i/s_i$  ratio is the bottleneck station.

Station	$WL_i/s_i$ ratio
1 (load/unload)	5.0/1 = 5.0 min
2 (mill)	19.5/1 = 19.5 min ← Bottleneck
3 (drill)	18.4/1 = 18.4 min
4 (material handling)	7.5/1 = 7.5 min

Bottleneck is station 2:

Apply formula:

$$R_p^* = \frac{s^*}{WL^*}$$

$$R_p^* = 1/19.5 = 0.05128 \text{ pc/min} = \mathbf{3.077 \text{ pc/hr}}$$

(b) Production rates for each product; apply formula for each:

$$R_{pj}^* = p_j R_p^*$$

$$R_{pA} = 0.05128(0.2) = 0.01026 \text{ pc/min} = \mathbf{0.6154 \text{ pc/hr}}$$

$$R_{pB} = 0.05128(0.3) = 0.01538 \text{ pc/min} = \mathbf{0.9231 \text{ pc/hr}}$$

$$R_{pC} = 0.05128(0.5) = 0.02564 \text{ pc/min} = \mathbf{1.5385 \text{ pc/hr}}$$

(c) Utilization of each machine in the system; apply formula:

$$U_i = \frac{WL_i}{s_i} R_p^*$$

$$U_1 = (5.0/1)(0.05128) = 0.256 = \mathbf{25.6\%}$$

$$U_2 = (19.5/1)(0.05128) = 1.0 = \mathbf{100\%}$$

$$U_3 = (18.4/1)(0.05128) = 0.944 = \mathbf{94.4\%}$$

$$U_4 = (7.5/1)(0.05128) = 0.385 = \mathbf{38.5\%}$$

(d) Number of busy servers at each station; apply formula:

$$BS_i = WL_i R_p^*$$

$$BS_1 = (5.0)(0.05128) = \mathbf{0.256 \text{ servers}}$$

$$BS_2 = (19.5)(0.05128) = \mathbf{1.0 \text{ servers}}$$

$$BS_3 = (18.4)(0.05128) = \mathbf{0.944 \text{ servers}}$$

$$BS_4 = (7.5)(0.05128) = \mathbf{0.385 \text{ servers}}$$

**END EXAMPLE 15.1**

### 15.7.2 Extended Bottleneck Model

The extended bottleneck model replaces the assumption made in the original bottleneck theory of a system with 100% utilization, with a model that assumes a closed queuing network in which there are always a certain number of workparts in the FMS. This number of parts in the system is depicted as  $N$ , and the assumption is made that when one part is exiting the system, a raw part is entering; thus  $N$  remains constant. If  $N$  is small, then there will be some idle time for some stations owing to starving. If this is the case, then the production rate of the FMS will be less than  $R_p^*$ . If  $N$  is large, then the system will be fully loaded with parts, and there will be queues of parts waiting in front of workstations to be processed. In this case,  $R_p^*$  does provide a good estimate of the production capacity of the system, albeit with a large work-in-process and high manufacturing lead time.

#### KEYPOINT

The extended bottleneck model assumes a closed queuing network in which there are always a certain number of workparts in the FMS.

**END KEYPOINT**

In effect, work-in-process corresponds to  $N$ , and manufacturing lead time (MLT) becomes the sum of processing times at the workstation, plus waiting time; or:

$$MLT = \sum_{i=1}^n WL_i + WL_{n+1} + T_w$$

where  $T_w$  is the mean waiting time experienced by a part due to queues at the stations; and all other expressions have the same meaning as in the bottleneck model. Work-in-process and manufacturing lead time are correlated: if work-in-process (and therefore  $N$ ) is small, then manufacturing lead time will take on its smallest possible value, because waiting time approaches zero; if, on the other hand, work-in-process (and also  $N$ ) are large, then manufacturing lead time will be long, as there will be waiting in the system. This gives two cases that require adjustments to the basic bottleneck model. These cases exploit a formula known as Little's formula, which comes from queuing theory; it establishes the relationship between the mean time a unit spends in the system, the mean processing rate of items in the system, and the mean number of units in the system. Here, we can express it as:

$$N = R_p (MLT)$$

The two cases are:

#### BULLETLIST

##### Case 1

When  $N$  is small, production rate is less than the bottleneck case because the bottleneck station is not fully utilized. The waiting time ( $T_w$ ) is theoretically zero, which gives the equation:

$$MLT_1 = \sum_{i=1}^n WL_i + WL_{n+1}$$

$MLT_1$  denotes manufacturing lead time for case 1. Production rate can be estimated, using Little's formula:

$$R_p = \frac{N}{MLT_1}$$

Production rates of the individual parts are given by:

$$R_{pj} = p_j R_p$$

## Case 2

When  $N$  is large, the estimate of maximum production rate made previously hold true:

$$R_p^* = \frac{s^*}{WL^*}$$

where  $*$  denotes that production rate is constrained by the bottleneck station. Production rates of the individual products are given by:

$$R_{pj}^* = p_j R_p^*$$

Using Little's formula, manufacturing lead time for case 2 is:

$$MLT_2 = \frac{N}{R_p^*}$$

The mean time a part spends in the system is estimated as:

$$T_w = MLT_2 - \left( \sum_{i=1}^n WL_i + WL_{n+1} \right)$$

ENDLIST

The decision to use either case 1 or case 2 depends on the value of  $N$ . The dividing line is determined by recourse to the following formula:

$$N^* = R_p^* \left( \sum_{i=1}^n WL_i + WL_{n+1} \right) = R_p^* (MLT_1)$$

where  $N^*$  is the critical value of  $N$ . If  $N^*$  is greater than  $N$  then we apply case 1; if  $N^*$  is less than or equal to  $N$  then we apply case 2.

### KEYPOINT

There are two cases considered in the extended bottleneck model, where the number of parts in the system is the critical determinant.

**END KEYPOINT**

### 15.7.3 Sizing the Flexible Manufacturing System

The bottleneck model can be used to calculate the number of servers required at each workstation to achieve a specified production rate. To make the

computation, we need to know the part mix, process routings, and processing times so that workloads may be established. Given the workloads, the number of servers required at station  $i$  is:

$$s_i \geq R_p(WL_i)$$

Because the number of servers at each workstation must be an integer, station utilization may be less than 100% for most if not all of the stations.

#### **KEYPOINT**

The bottleneck model may also be used to calculate the number of servers required at each workstation in the FMS.

#### **END KEYPOINT**

### **15.7.4 What the Equations Tell Us**

The following may be made based upon the above analysis:

#### **KEYPOINT**

Remarks arising from FMS Quantitative Analysis:

#### **BULLETLIST**

For a given product or part mix, the total production rate of the FMS is ultimately limited by the productive capacity of the bottleneck station, which is the station with the maximum workload per server.

If the product or part mix ratios can be relaxed, it may be possible to increase total FMS production rate by increasing the utilization of non-bottleneck stations.

The number of parts in the FMS at any time should be greater than the number of servers in the system. A ratio of around two parts per server is probably optimum, assuming that the parts are distributed throughout the FMS to ensure that one part is waiting at every station. This is especially critical at the bottleneck station.

If work-in-process is kept too low, the production rate of the system will be impaired.

If work-in-process is set too high, then manufacturing lead time will be long, with no improvement in production rate.

As a first approximation, the bottleneck model can be used to estimate the number of servers at each station to achieve a specified overall production rate of the system.

#### **ENDLIST**

#### **END KEYPOINT**

## 15.8 Unit Review

### BULLETLIST

A flexible manufacturing system (FMS) is a highly automated group technology machine cell, consisting of a group of processing workstations—often computer numerical control machine tools—that are interconnected by an automated material handling and storage system, and controlled by a distributed computer system.

Group technology is a manufacturing philosophy in which similar parts are identified and grouped together to take advantage of their similarities in design and production.

Cellular manufacturing is an application of group technology in which similar machines or processes have been aggregated into cells, each of which is dedicated to the production of a part, product family, or limited group of part families. The FMS represents the most highly automated version of cellular manufacturing.

Flexibility has three primary capabilities in the FMS; it must have the capability: to identify and distinguish among the different incoming part or product styles processed by the system; of performing a quick changeover of operating instructions; and of performing a quick changeover of physical set-up.

The four tests for flexibility in FMS research are as follows:

### NUMLIST

1. Part variety test—can the system handle different part styles in a non-batch mode?
2. Schedule change test—can the system adapt to changes in the production schedule, either in the product mix or the expected production volume?
3. Error recovery test—can the system recover undisrupted from equipment malfunctions and breakdowns?
4. New part test—can new part designs be introduced into the existing product mix with relative ease?

### ENDLIST

Each FMS is custom-built and unique; however it can be characterised by the number of machines it contains, or by whether it is a dedicated or random-order FMS, in terms of the parts it processes.

FMSs can be distinguished in terms of the number of machines it possesses as single machine cells, flexible manufacturing cells, and flexible manufacturing systems.

The FMS can be examined to determine the level of flexibility it maintains. There are two levels: dedicated FMS, and random-order FMS.

In dedicated FMS types a limited variety of parts is catered for on a custom-built FMS with specialist machines to achieve high production rates. In the random-order FMS type, a large part family with wide possibilities for future design changes, and changing production schedules, is catered for on a general-purpose FMS with random-order sequencing of parts.

Basic components of an FMS are: workstations, material handling and storage systems, computer control system, and the personnel that manage and operate the system.

The types of workstations that may be utilized in FMSs include: load/unload stations, machining and turning stations, other industry-specific processing stations (such as sheet metal fabrication and forging), assembly stations, and supporting stations.

Functions of the material handling and storage system in FMSs include: the allowance of random, independent movement of workparts between stations; the handling of a variety of workpart configurations; the provision of temporary storage; the provision of convenient load and unload stations; and the creation of compatibility with computer control.

FMS material handling equipment consists of a primary handling system to establish material handling lay-out, and a secondary handling system to transfer parts from the primary material handling system to the workhead of the processing station, or to a supporting station.

There are five categories of FMS layout; these are: in-line layout; loop layout; ladder layout; open field layout; and robot-centred layout.

The computer control system in an FMS has the following functions: workstation control; distribution of control instructions to workstations; production control; traffic control; shuttle control; workpiece monitoring; tool control; performance monitoring and reporting; and diagnostics.

Although not intrinsically considered as part of the FMS, humans nevertheless manage the overall operations of the system, and perform a number of supporting tasks in the system.

Historically, FMSs that could process non-rotational parts have been more predominant than FMSs that could process rotational parts. The reasons for this include the early development of system components to handle non-rotational parts, and the need to machine non-rotational parts in a less expensive, more efficient, manner.

Benefits of successful FMS applications include: increased machine utilization; fewer machines required; reduction in the amount of factory floor space required; greater responsiveness to change; reduced inventory requirements; lower manufacturing lead times; reduced direct labour requirements and higher labour productivity; and opportunities for unattended production.

Major issues of planning for the creation of FMSs include: part family considerations; processing requirements; physical characteristics of the workparts; and production volume.

Major issues of design for the creation of FMSs include: workstation type; consideration of the variations in process routings and FMS layout; choice of material handling system; work-in-process and storage capacity decisions; tooling choices; and pallet fixture considerations.

FMS operational problems include issues of: scheduling and dispatching; machine loading; part routing; part grouping; tool management; and pallet and fixture allocation.

FMSs are generally analysed under deterministic and queuing methodologies in the early stage of system; while, in later stages, discrete event simulation is used to handling general system characteristics. Other techniques, including mathematical programming, heuristics, and operational research techniques, are used to capture various realities within the FMS, as necessary.

For deterministic modelling, we examine the bottleneck model, which is a model that examines the production system's upper limit, given that the product mix flowing through the FMS is fixed.

The bottleneck model allows us to determine initial values for the average workload of individual stations in the FMS, the average number of transports in the system, and the average workload of the material handling system.

Additional performance measures that can be computed for the bottleneck model include: the workload per server; the maximum production rate; individual part production rates; and the utilization of individual workstations, and the overall FMS utilization.

The extended bottleneck model assumes a closed queuing network in which there are always a certain number of workparts in the FMS.

There are two cases considered in the extended bottleneck model, where the number of parts in the system is the critical determinant.

The bottleneck model may also be used to calculate the number of servers required at each workstation in the FMS.

Remarks arising from FMS Quantitative Analysis:

#### BULLETLIST

For a given product or part mix, the total production rate of the FMS is ultimately limited by the productive capacity of the bottleneck station, which is the station with the maximum workload per server.

If the product or part mix ratios can be relaxed, it may be possible to increase total FMS production rate by increasing the utilization of non-bottleneck stations.

The number of parts in the FMS at any time should be greater than the number of servers in the system. A ratio of around two parts per server is probably optimum, assuming that the parts are distributed throughout the FMS to ensure that one part is waiting at every station. This is especially critical at the bottleneck station.

If work-in-process is kept too low, the production rate of the system will be impaired.

If work-in-process is set too high, then manufacturing lead time will be long, with no improvement in production rate.

As a first approximation, the bottleneck model can be used to estimate the number of servers at each station to achieve a specified overall production rate of the system.

ENDLIST

ENDLIST

### **14.10 Self-Assessment Questions**

NUMLIST

What is meant by a flexible manufacturing system?

What is group technology? How does it relate to cellular manufacturing?

What are the three primary capabilities of flexibility in the FMS?

What are the four tests for flexibility in FMS research?

How are different types of FMS specified?

What are the basic components of an FMS?

List the five categories of FMS layout.

What are the benefits of a successful FMS implementation?

What are the major issues of planning for the creation of FMSs?

What types of quantitative analysis may be used with regard to FMSs?

What are the bottleneck model and the extended bottleneck model?

List some points that arise from FMS quantitative analysis research.

ENDLIST

#### **14.11 Answers to Self-Assessment Questions**

NUMLIST

A flexible manufacturing system (FMS) is a highly automated group technology machine cell, consisting of a group of processing workstations—often computer numerical control machine tools—that are interconnected by an automated material handling and storage system, and controlled by a distributed computer system.

Group technology is a manufacturing philosophy in which similar parts are identified and grouped together to take advantage of their similarities in design and production. Cellular manufacturing is an application of group technology in which similar machines or processes have been aggregated into cells, each of which is dedicated to the production of a part, product family, or limited group of part families. The FMS represents the most highly automated version of cellular manufacturing.

The three primary capabilities of flexibility in the FMS are the following; it must have the capability: (1) to identify and distinguish among the different incoming part or product styles processed by the system; (2) of performing a quick changeover of operating instructions; and (3) of performing a quick changeover of physical set-up.

The four tests for flexibility in FMS research are as follows:

NUMLIST

1. Part variety test—can the system handle different part styles in a non-batch mode?

2. Schedule change test—can the system adapt to changes in the production schedule, either in the product mix or the expected production volume?
3. Error recovery test—can the system recover undisrupted from equipment malfunctions and breakdowns?
4. New part test—can new part designs be introduced into the existing product mix with relative ease?

ENDLIST

Each FMS is custom-built and unique; however it can be characterised by the number of machines it contains, or by whether it is a dedicated or random-order FMS, in terms of the parts it processes. FMSs can be distinguished in terms of the number of machines it possesses as single machine cells, flexible manufacturing cells, and flexible manufacturing systems. The FMS can also be examined to determine the level of flexibility it maintains. There are two levels: dedicated FMS, and random-order FMS.

Basic components of an FMS are: workstations, material handling and storage systems, computer control system, and the personnel that manage and operate the system.

The five categories of FMS layout are: in-line layout; loop layout; ladder layout; open field layout; and robot-centred layout.

The benefits of a successful FMS application include: increased machine utilization; fewer machines required; reduction in the amount of factory floor space required; greater responsiveness to change; reduced inventory requirements; lower manufacturing lead times; reduced direct labour requirements and higher labour productivity; and opportunities for unattended production.

Major issues of planning for the creation of FMSs include: part family considerations; processing requirements; physical characteristics of the workparts; and production volume. Major issues of design for the creation of FMSs include: workstation type; consideration of the variations in process routings and FMS layout; choice of material handling system; work-in-process and storage capacity decisions; tooling choices; and pallet fixture considerations.

FMSs are generally analysed under deterministic and queuing methodologies in the early stage of system; while, in later stages, discrete event simulation is used to handling general system characteristics. Other techniques, including mathematical programming, heuristics, and operational research techniques, are used to capture various realities within the FMS, as necessary.

In deterministic modelling, the bottleneck model is a model that examines the production system's upper limit, given that the product mix flowing through the FMS is fixed. The bottleneck model allows us to determine initial values for the average workload of individual stations in the FMS, the average number of transports in the system, and the average workload of the material handling system. The extended bottleneck model assumes a closed queuing network in which there are always a certain number of workparts in the FMS. There are two cases considered in the extended bottleneck model, where the number of parts in the system is the critical determinant.

The following points arise from FMS quantitative analysis research:

BULLETLIST

For a given product or part mix, the total production rate of the FMS is ultimately limited by the productive capacity of the bottleneck station, which is the station with the maximum workload per server.

If the product or part mix ratios can be relaxed, it may be possible to increase total FMS production rate by increasing the utilization of non-bottleneck stations.

The number of parts in the FMS at any time should be greater than the number of servers in the system. A ratio of around two parts per server is probably optimum, assuming that the parts are distributed throughout the FMS to ensure that one part is waiting at every station. This is especially critical at the bottleneck station.

If work-in-process is kept too low, the production rate of the system will be impaired.

If work-in-process is set too high, then manufacturing lead time will be long, with no improvement in production rate.

As a first approximation, the bottleneck model can be used to estimate the number of servers at each station to achieve a specified overall production rate of the system.

ENDLIST